



AJP PR7 USER MANUAL



AJP Motos, SA - Disclaims all liabilities for any errors or omissions present in this manual and reserves the right to make changes that reflect the on-going development. Illustrations and diagrams in this document can differ from the genuine components. The partial or full reproduction of this document is not allowed without written authorization.

2st. Edition (09-2022)

Copyright by

AJP Motos, SA

Technical Service

Rua de Santana, 91

4620-510 Pias, Lousada

Portugal

Tel: +351 255 815 122

Fax: +351 255 815 123

Website: www.ajpmotos.com

2st. Edition (09-2022)

IMPORTANT INFORMATION

WE STRONGLY RECOMMEND YOU TO READ THIS MANUAL CAREFULLY AND COMPLETELY BEFORE GOING ON YOUR FIRST RIDE. THE MANUAL CONTAINS A GREAT DEAL OF INFORMATION AND ADVICES, WHICH WILL HELP YOU USE AND HANDLE YOUR MOTORCYCLE PROPERLY. IN YOUR OWN INTEREST, PLEASE PAY ATTENTION TO NOTICES THAT ARE MARKED AS FOLLOWS:

DANGER

IGNORING THESE INSTRUCTIONS CAN ENDANGER YOUR PHYSICAL INTEGRITY AND YOUR LIFE, AS WELL AS OTHERS.

WARNING

IGNORING THESE INSTRUCTIONS CAN DAMAGE PARTS OF YOUR MOTORCYCLE AND/OR MAKE THE MOTORCYCLE NO LONGER SAFE TO RIDE ANYMORE.

TAKE SPECIAL CARE TO FOLLOW THE RECOMMENDED RUN IN, INSPECTION AND MAINTENANCE INTERVALS. FOLLOWING THESE GUIDELINES WILL SIGNIFICANTLY INCREASE THE LIFE OF YOUR MOTORCYCLE. BE SURE TO HAVE ANY MAINTENANCE JOBS PERFORMED BY AN AUTHORIZED AJP DEALER.

PLEASE DON'T FORGET TO WEAR A HELMET, EYE PROTECTION AND PROTECTIVE CLOTHING WHEN GOING FOR A RIDE.

WE WISH YOU ENJOY YOUR AJP!

TABLE OF CONTENTS

TABLE OF CONTENTS	iv
Chapter A. CONSUMER INFORMATION	A.1
ACCESSORY INSTALLATION AND SAFETY TIPS	A.2
SAFE RIDING RECOMMENDATIONS	A.3
MOTORCYCLE IDENTIFICATION	A.4
BREAKING-IN	A.5
INSPECTIONS BEFORE RIDING	A.6
RIDING TIPS	A.8
MOTORCYCLE CLEANING	A.12
STORAGE PROCEDURES	A.13
CONSERVATION FOR WINTER OPERATION	A.14
Chapter B. COMPONENTS LOCATION	B.1
CONTROLS	B.5
Chapter C. MAINTENANCE SCHEDULE	C.1
Chapter D. MAINTENANCE AND ADJUSTMENTS	D.1
LUBRIFICATION POINTS	D.2
CHECKING ENGINE OIL LEVEL	D.3
CHANGING ENGINE OIL	D.4
REPLACING MAIN OIL FILTER	D.5
CHECKING COOLANT LEVEL	D.6

REPLACING COOLANT LIQUID.....	D.7
RADIATOR FAN	D.7
CHECKING AND ADJUSTING THE STEERING HEAD BEARINGS.....	D.8
CLEANING FRONT FORK DUST SEALS.....	D.8
ADJUSTING FRONT FORK SUSPENSION.....	D.9
ADJUSTING REAR SUSPENSION.....	D.10
ADJUSTING DRIVE CHAIN.....	D.11
DRIVE CHAIN MAINTENANCE	D.12
TIRES CONDITION	D.13
TIRES PRESSURE.....	D.13
CHECKING SPOKES TENSION.....	D.14
BRAKE DISC.....	D.15
BRAKE DISC.....	D.15
CHECKING FRONT BRAKE PADS	D.16
CHECKING REAR BRAKE PADS.....	D.16
FRONT BRAKE MASTER CYLINDER	D.17
CHECKING FRONT BRAKE FLUID LEVEL	D.17
REFILLING FRONT BRAKE FLUID.....	D.18
CHECKING REAR BRAKE FLUID LEVEL.....	D.18
REFILLING REAR BRAKE FLUID	D.19
CHANGING REAR BRAKE PEDAL POSITION	D.19

REMOVING THE BATTERY	D.20
RECHARGING THE BATTERY	D.21
CHECKING SPARK PLUG	D.22
FUSES.....	D.23
REPLACING HEADLIGHT LAMP.....	D.24
REPLACING TAILLIGHT	D.25
REPLACING TURN INDICATOR LIGHTS	D.25
TABLET CASE ASSEMBLY	D.26
TABLET CASE ASSEMBLY	D.27
CLEANING AIR FILTER	D.28
CHECKING EXHAUST SYSTEM.....	D.29
Chapter E. TECHNICAL SPECIFICATIONS.....	E.1

Chapter A.
CONSUMER INFORMATION

ACCESSORY INSTALLATION AND SAFETY TIPS

In the market there is a variety of accessories for AJP motorcycles. AJP cannot have direct control over the quality or suitability of accessories you may want to purchase. The addition of unsuitable accessories can lead to unsafe operating conditions. Contact your AJP dealer to assist you in selecting accessories and install them correctly.

DANGER

Improper accessories or modifications can make your motorcycle unsafe and can lead to an accident.

Never modify the motorcycle with improper or poorly installed accessories.

Follow all instructions in this manual regarding accessories and modifications.

Consult your AJP dealer if you have any questions.

Certain accessories displace the rider from his normal position, which limit the freedom of movement and may limit the motorcycle control ability.

Additional electric accessories may overload the electric system. Severe overloads may damage the wiring harness or create a dangerous situation due to the loss of electric power during the operation of the motorcycle.

When carrying additional load on the motorcycle, mount the load as low as possible. An improperly mounted load can create a high center of gravity, making the motorcycle dangerous and difficult to handle. The size of the load can also affect the aerodynamics and handling of the motorcycle. Balance the load between the left and right sides of the motorcycle and fasten it securely.

Note: For addition information consult our website: www.ajpmotos.com

SAFE RIDING RECOMMENDATIONS

WEAR A HELMET

Motorcycle safety equipment starts with a quality helmet. One of the most serious injuries that can happen is a head injury. ALWAYS wear a properly homologated helmet. You should also wear suitable eyes protection.

RIDING CLOTHING

Loose or inappropriate clothing can be uncomfortable and unsafe for motorcycle riding. Choose good quality motorcycle riding apparel when riding your motorcycle. Wear gloves, strong boots that protect the ankle, long pants and long sleeve shirt/jacket.

INSPECTION BEFORE RIDING

Review all the instructions in the “INSPECTIONS BEFORE RIDING” section in this manual. Do not forget to perform an entire inspection to ensure the safety of the motorcycle.

FAMILIARIZE YOURSELF WITH THE MOTORCYCLE

Your riding skill and your mechanical knowledge form the basis for safe riding. We recommend you to practice riding your motorcycle in an open area without obstacles until you are familiar with your motorcycle and its controls.

KNOW YOUR OWN LIMITS

Always ride within the limits of your skills. Knowing your limits and keep within them are the foundation to avoid accidents and injuries.

BE EXTRA SAFETY CONSCIOUS ON BAD WEATHER DAYS OR BAD ROAD CONDITIONS

Riding on bad weather days requires extra attention. Braking distances double in a rainy day. If you are not sure about road conditions ride slower and with double caution!

MOTORCYCLE IDENTIFICATION

Chassis and engine serial numbers are used for the motorcycle registration. Also they should be used by the AJP dealers to perform the request AJP MOTOS spare parts.

HOMOLOGATION PLATE

Homologation plate (1) of the motorcycle is located in the right side of the chassis, close to the steering column. The plate contains the homologation number, serial number and the noise level at a specified engine rpm.

CHASSIS/FRAME NUMBER

Chassis number (2) is engraved on the right side of the steering column.

ENGINE SERIAL NUMBER

Engine serial number (3) is engraved on the left side of the engine on top of the crankcase.

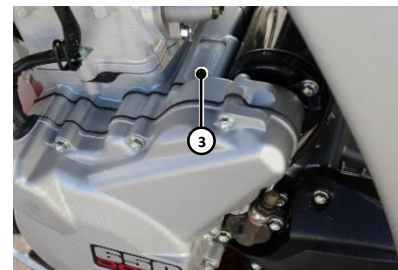
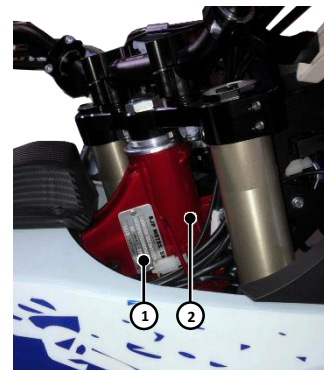

BREAKING-IN

The following recommendations show the importance of a proper break-in to achieve maximum life and performance for the new AJP model.

Even high precision machined sections of engine components have rougher surfaces that require be operated with the other component surfaces, in order to adjust to each other. Therefore, every engine needs to be broken-in during the first 1000 km.

For this reason, do not load the engine more than 50% of its capacity during the first 500 kilometers and avoid full throttle. After 500 km, you can load the engine up to 75% of its capacity, using the gearbox frequently.

Allow sufficient idling time (1-2 minutes) with a cold or warm engine start up, before applying load or revving the engine. This procedure allows the lubrication oil to reach all critical engine components.

The first 1000 km maintenance service is the most important maintenance that your AJP will receive. The motorcycle must be checked carefully, restoring all the adjustments, retightening fasteners and updating the injection system condition.

WARNING

Incorrect break-in may cause severe damage of components or significantly reduce the motorcycle life time.

INSPECTIONS BEFORE RIDING

In each start off, the engine must be in perfect mechanical conditions. For safety reasons, the owner/driver should make overall check routine before each ride. The following inspections should be performed:

1. **Oil level:** Insufficient oil quantity will result in premature wear in engine components, damaging the engine itself;
2. **Fuel:** Check if there is enough fuel in the tank;
3. **Drive chain:** Verify the drive chain clearance and condition. A chain with incorrect tension or lack of lubricant can result in excessive wear and damage other components. Aside from resulting in premature wear, the chain or transmission axle may break;
4. **Tires:** Check the air pressure and the existence of cuts or punctures in the tires, replace the tires if necessary. The tread must also follow the legal restrictions. Insufficient tread and incorrect air pressure will reduce the driving performance;
5. **Brakes:** Inspect the braking system and brake fluid level. The fluid level below the minimum mark can indicate a possible fluid leak or completely worn pads. Also check the brake hoses and the brake linings thickness, as well the free play of the brake lever and pedal;
6. **Electric system:** Check correct function lights, indicators and horn while the engine is running;
7. **Steering:** Check for smoothness, restriction of movement and steering column bearings looseness;
8. **Throttle:** With the engine off, inspect the correct play, smooth operation and the return to close position;
9. **Clutch:** Examine for correct play, smoothness and progressive action;
10. **Suspension:** Inspect suspensions for soft movements;
11. **Emergency switch:** Check for the correct function of the emergency switch, by turning off the engine with the switch.
12. **Luggage:** In case of taking any luggage, check if it is safety secured.

DANGER

Ignoring these inspections or improperly preserve the motorcycle will increase the chance of an accident or component damage.

DANGER

Using worn, improperly inflated or incorrect tires will reduce motorcycle stability and can cause an accident.

Front and rear tires are only allowed to be fitted with same homologated original profile tires.

DANGER

Wear suitable clothing when driving a motorcycle. Never forget to wear helmet, gloves and boots, even in short trips. Protective clothing should be brightly colored to make you visible to other drivers.

Do not drive after consuming alcohol.

DANGER

Never ride your motorcycle on full throttle or rev while the engine is cold. Otherwise the piston will be warming up faster than the cylinder, which can cause severe engine damage.

Checking maintenance items with a running engine can be dangerous. You can be severely injured if your hands or clothing get caught in moving parts, such as tires or drive chain.

DANGER

Observe the traffic regulation and drive defensively, trying to look ahead as far as possible to early recognize any possible obstacle.

Adjust your driving speed according to the conditions and driving skills. Drive carefully in unknown roads or trails, if possible with company in case of any problem occur.

Replace helmet visor or goggle lens when scratched or damaged. Do not repair twisted handlebar, replace it immediately.

RIDING TIPS

INSTRUCTIONS FOR INITIAL OPERATION

- Verify if your AJP dealer performed a previous preparation of the motorcycle.
- Familiarize yourself with all operating motorcycle controls. Get used to the handling on an empty and open space before longer rides. Try also drive as slow as possible to improve your feeling of the motorcycle.
- Hold the handlebar with both hands and maintain your feet on the footrest while driving.
- Remove your foot from the brake pedal when you are not braking. Otherwise the brake system overheat.
- For safety reasons do not modified the vehicle and always use AJP original spare parts.
- Motorcycle are sensitive to changes in weight distribution. In case of caring luggage with you, secure it as close as possible to the middle to distribute weight on both sides.

ENGINE START

Raise up the side stand and turn the ignition key to ON position.

Engage the neutral gear (the neutral indicator should be on). Check if the emergency switch is in the ON position.

Actuate the electric starter motor button without operate the throttle grip.

DANGER

Before start off check if the side stand is fully folded up. Otherwise, the side stand can drag on the ground causing control loss.

WARNING

Never operate the electric starter more than 5 seconds. Wait at least 10 seconds before trying again.

STARTING OFF

Press the clutch lever and put the engine in first gear. Slowly release the clutch lever and open the throttle at the same time.

USING THE GEARBOX

The first gear is referred as the start off or uphill gear. Depending on the conditions (traffic, surface inclination, etc.) you should shift to the suitable gear. To shift between gears, simultaneously close throttle and operate the clutch lever, while operating the gearshift pedal to switch gears.

WARNING

High rpm rates in a cold engine will reduce the engine lifetime. We recommend to run the engine in moderate rpm on first 10 km (6 miles), giving it the chance to warm up.

Never shift down gears with throttle wide open. The engine will over-rev, damaging the valves and the gearbox.

If any abnormal vibrations occur while driving, check for loosen bolts in the engine. If the vibration remains contact an AJP dealer.

If you notice any unusual operation-related noise while riding, stop immediately. Shut the engine off and contact an AJP dealer.

Never start your motorcycle without air filter placed, otherwise dust and dirt may penetrate the engine creating premature wear or damaging it.

BRAKING

Apply both brakes at the same time while closing the throttle. When driving on sandy, wet or slippery ground use mainly the rear brake. Avoid blocking the wheels, otherwise you may lose control of the motorcycle.

Use the engine brake effect when driving downhill to assist the brakes. Lower one or two gears without over-speeding the engine. Therefore, you will not need to use continuously the brakes, avoiding overheat.

DANGER In case of rain, washing the motorcycle or ride through wet off-road tracks, the wet or dirty brake discs can delay the braking effect. Brakes must be actuated until the brake discs are dry and/or clean.

Dirty brakes cause increased wear of brake pads and discs.

DANGER Hard braking on wet, rough or slippery surfaces can cause wheel skid and control loss. Brake slightly and carefully on adverse or irregular surfaces.

Hard braking while turning may cause wheel slide and control loss. Brake before starting to turn.

DANGER Inexperienced riders tend to under use the front brake. This can cause increased braking distance and lead to collisions. Using only front or rear brake can cause skidding and control loss.

STOPPING AND PARKING

In order to stop apply the brakes until the motorcycle is immobilized. To turn off the engine turn the key to OFF position on the ignition switch or press the emergency switch to the OFF position. Park the vehicle on solid ground and in a secure position. Lock the steering.

DANGER

Never leave the motorcycle without supervision while the engine is running or with children nearby.

Do not touch the motorcycle components after a ride. The components as engine, exhaust pipe, brakes and others can remain with high temperatures and cause burns.

Be careful when parking the vehicle. Place on areas out of reach of pedestrians and easy flammable materials.

MOTORCYCLE CLEANING

Clean your motorcycle often in order to maintain the appearance of plastic surfaces and avoid corrosion.

The recommended method would be to use a sponge and warm water at 30-35°C mixed with a regular washing detergent. The hard dirt can be removed before washing with the help of a soft water jet.

Recommendations:

- Use a regular cleaning detergent to wash the motorcycle. Especially dirty parts should be cleaned with the help of a brush;
- Before cleaning with water, cover the muffler and the air filter cover holes to prevent water going inside;
- After cleaning with a soft water jet, dry the motorcycle with compressed air and a piece of fabric. Remove the materials used to cover up the muffler and air filter cover holes, then start the engine and let it run for few minutes;
- Take a short drive until the engine reach the operating temperature and use the brakes. Doing this procedure the residual water will evaporate due the warm parts off engine and brakes;
- Once the motorcycle has cooled down, lubricate all sliding and bearings points. Lubricate as well the chain with a chain spray;
- To avoid any malfunction of the electric system, you should apply spray on the emergency switch, starter motor button, light switch and connectors with a contact spray.

WARNING

Never direct a high pressure jet to some sensitive points of motorcycle, such as electronic components (ECU, throttle body sensor, switches, relays, connectors, controls cables, among others), wheels and steering column bearings.

If water or dust penetrates on those components, oxidation or corrosion might occur, resulting in weak electric contact. This can lead to motorcycle malfunctions or cause premature damage of those components.

STORAGE PROCEDURES

In case of motorcycle storage for long period of time, the following instructions should be take:

- Clean the motorcycle thoroughly (see MOTORCYCLE CLEANING);
- Remove the spark plug and fill the cylinder with approximately 5 cc of engine oil through the opening. Assembly the spark plug, without the spark plug cap connected, and actuate the start motor in order to distribute the oil into the cylinder walls;
- Remove the fuel into an appropriate container;
- Correct the tire pressure;
- Lubricate pivot points of control levers, foot rests and others, as well as the chain;
- Remove the battery (see REMOVING THE BATTERY);
- Storage on a dry place where the motorcycle is not subject to excessive temperature fluctuations;
- Cover the motorcycle with a blanket. Do not use air impermeable materials, otherwise humidity might be retained and cause corrosion.

WARNING

Do not let engine run in short time period (less than 5 minutes). Without warming enough the engine, water vapor will condense while cooling down, causing valve and exhaust corrosion.

RE-INITIATION AFTER STORAGE

- Assembly the charged battery (check polarity);
- Fill up the fuel tank with fresh fuel;
- Check the motorcycle before each start (see INSPECTIONS BEFORE RIDING).

CONSERVATION FOR WINTER OPERATION

In case of using the motorcycle in winter and on road where salt spray was applied, additional precautions measures must be taken against the aggressive road salt.

- Clean the motorcycle thoroughly and dry completely after each ride;
- Treat the engine, swing arm and all other galvanized parts (except for brake disks) with a wax based anti-corrosion agent.

Chapter B.

COMPONENTS LOCATION

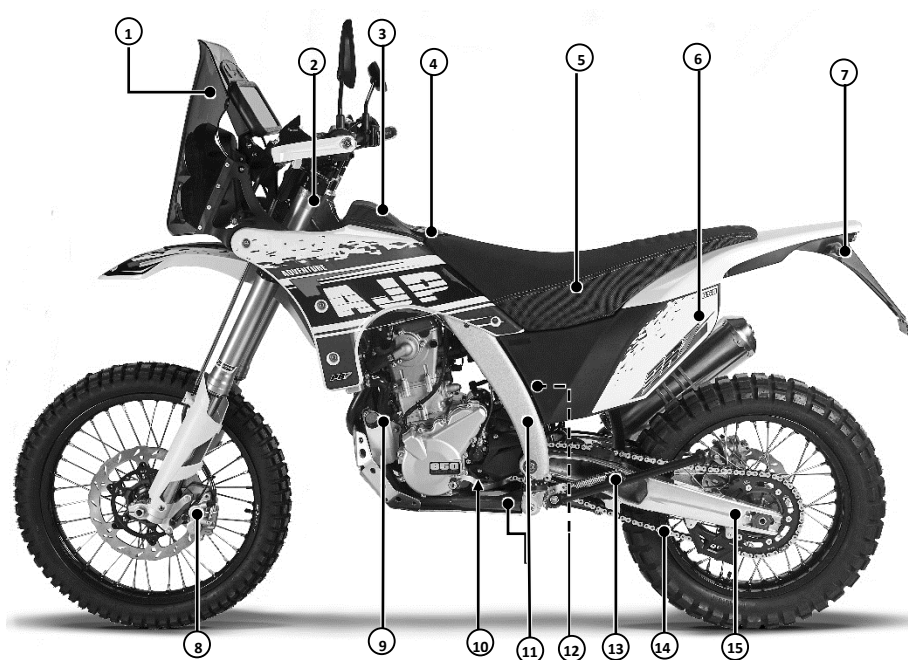

1.	Windshield	6.	Fuel tank	11.	Chassis
2.	Front suspension	7.	Turn indicators (blinkers)	12.	Rear suspension
3.	Air filter cover	8.	Brake caliper	13.	Side stand
4.	Fuel tank cap	9.	Coolant expansion tank	14.	Drive chain
5.	Seat	10.	Gearshift pedal	15.	Swing arm

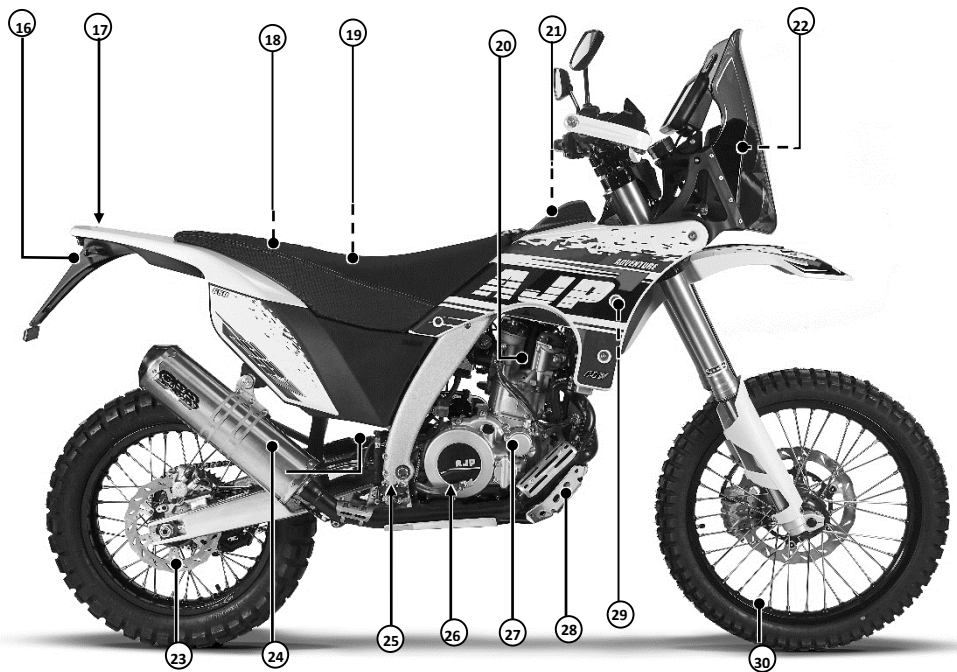

16.	Number-plate holder	21.	Air filter	26.	Rear brake pedal
17.	Taillight	22.	Headlights	27.	Engine
18.	Battery	23.	Brake disc	28.	Engine skid plate
19.	Fuses	24.	Exhaust system	29.	Radiators
20.	Spark plug	25.	Foot-rest	30.	Rim



1.	Rear view mirrors	6.	Front brake master cylinder	11.	Turn indicator switch
2.	Low/High beam switch	7.	Emergency switch	12.	Ignition switch and steering lock
3.	Clutch master cylinder	8.	Hand guard	13.	Electric start button
4.	Instrument panel	9.	Clutch lever	14.	Throttle grip
5.	Tablet (optional)	10.	Horn button	15.	Front brake lever

CONTROLS

KEYS

This motorcycle comes with a pair of keys. Be aware to keep one of the keys in safe place, at home for instance, in order to access this key in case of need.

IGNITION SWITCH AND STEERING LOCK

ON - the ignition circuit is on and the engine can now be started. The key cannot be removed.

OFF - entire electrical circuits are cut off and the engine will not start. The key can be removed.

LOCK - the engine circuits are cut off and the engine will not start. The steering lock is actuated and the handlebar cannot turn. The key can be removed.

To change to the LOCK position, the ignition switch must be in OFF position and the handlebar turned all the way to the left.

WARNING



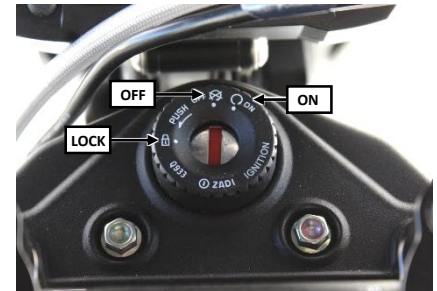

Do not try to ride with the ignition switch on LOCK position. With the steering locked is impossible to control the motorcycle.

Do not turn the ignition key to LOCK position while driving.



Note: Start the engine as soon as you turn key to ON position. Otherwise the battery will discharge due the consumption of the instrument panel, headlight and taillight.

INSTRUMENT PANEL

- 1. Turn indicator light**  (Green)
Flashes when the right/left turn indicator switch is operated.
- 2. High beam indicator light**  (Blue)
Turns on when the light switch is on the high beam position.
- 3. Tachometer**
Indicates the engine revolutions per minute (rpm).
- 4. Speedometer**
Indicates the instantaneous vehicle speed.
- 5. Engine oil indicator light**  (Red)
(The engine oil indicator is deactivated in this model)
- 6. Neutral indicator light** **N** (Green)
Activates when the neutral gear is engaged.
- 7. Fuel reserve**  (Amber yellow)
Turns on when the fuel level is below 3 liters.
- 8. Select button**
Swaps through the digits/settings when pressed.
- 9. Odometer/Trip meter**
Indicates the total/trip distance travelled.
- 10. Fuel meter**
Indicates the fuel level in the fuel tank.
- 11. Adjust button**
Changes the digits/settings when pressed.
- 12. Injection system diagnosis indicator**  (Amber yellow)
Turns on when fuel injection system associated error is detected.



INSTRUMENT PANEL SETTINGS

Background color

Press the Select button in the main screen to switch the background color (blue-orange-purple).

Odometer/trip meter

In order to switch between total and trip function press the Adjust buttons in the main screen.

Hold down the button for 3 seconds to reset the trip distance.

Clock setting

In the main screen press simultaneously the Select and Adjust button for 3 seconds. When the digit starts to flash, press the Adjust button to change the number.

WARNING

Do not change other settings in the instrument panel. Otherwise, incorrect measurements and information can be presented.



Note: Press Select button continuously to return to the main screen.

OBD SYSTEM

The AJP PR7 model is equipped with OBD system for the fuel injection system diagnosis. Located on the motorcycle right side, near to the instrument panel, is the OBD connector (1), which allows to get access to the injection system and its components information.

When diagnosed one associated fuel injection system problem automatically the diagnosis indicator light (2) in the instrument panel will turn on.

DANGER

If the injection system diagnosis indicator remains activated after the engine start contact your AJP dealer.

Driving the motorcycle with a diagnosed fuel injection system malfunction may damage components or cause an accident.

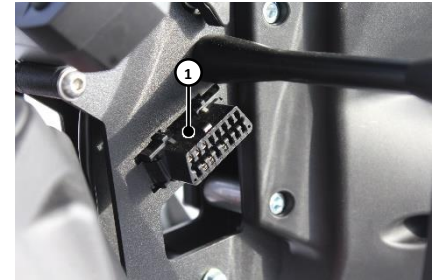

LEFT HANDLEBAR

1. Clutch lever

The clutch lever has the function of disengaging the driving system from rear wheel, mainly used in case of starting the engine or shifting gears. Gripping the clutch lever (1) disengages the clutch.

2. High beam flash button

The high beam flash when the button (2) is pressed.

3. Low/High beam switch

The low beam (☞) was designed to switch on whenever the ignition key is in the ON position. Simultaneously, front and rear presence lights are activated. In order to switch to the high beam light (☞) press down the switch (3), automatically the high beam indicator turns on.

4. Horn button

To actuate the horn sound press the button (4).

5. Turn indicator (blinkers) switch

- Turning the switch (5) to the left, the left turn indicator is activated.
- Turning the switch (5) to the right, the right indicator is activated.
- With the switch on center position, press it down to turn off.

When the turn indicator is switched to the left/right position, the turn indicator light in the instrument panel will start to flash. Press the button in the middle position to turn off the turn indicators.



DANGER

The turn indicator lights do not switch off automatically. Be aware to switch the indicator lights after turning or overtaking. Otherwise you will provide incorrect information to the others drivers.

RIGHT HANDLEBAR

1. Emergency switch (kill switch)

The emergency switch (1) has two positions:

- **ON** position (○) enables engine running.
- **OFF** position (⊗) stop the engine from running, cutting off the engine electric circuit.

To switch to the **OFF** position press down the switch.

2. Front brake lever

Operate the front brake by gripping brake lever (2) toward the throttle grip. Simultaneously the stop light in the taillight will light up.

3. Electric start button

Use the electric start button (3) to activate the starter motor. To start the engine, place the ignition key in the ON position and engage the neutral gear.

4. Throttle grip

The engine speed is controlled through the throttle grip (4) position. To increase the speed, rotate counter-clockwise (+). Release the grip to reduce the speed.

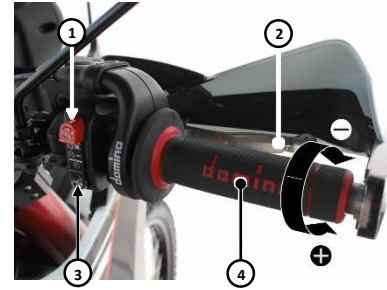

WARNING

If the emergency switch is on the **OFF** position, the engine will not start. Also the starter motor will not be activated. The instrument panel and the tablet will remain activated.

FUEL

The AJP PR7 engine requires unleaded gasoline with a 95 or higher octane index (containing up to 5% of ethanol). Never use lead fuel to avoid the destruction of the catalytic converter and the exhaust system.

WARNING

Using non-recommended or adulterated fuel can cause severe damage on fuel pump and engine. Ensure to use only unleaded gasoline with an octane index equal or higher than 95.

FUEL TANK CAP

To open the fuel tank cap (1) rotate the key counter-clockwise and remove the cap. To close, place back the cap and turn the key clockwise.

DANGER

Fuel is highly flammable and harmful to the health. Handled with caution.

Do not fill the motorcycle fuel tank near to flames or other ignition sources. Always turn off the engine before filling the tank.

Do not drop fuel over the hot areas of the motorcycle, such as engine and exhaust pipe. Clean quickly in case of dropping fuel.

In case of fuel ingestion or get in touch with eyes, search for medical treatment immediately.

Do not dispose fuel in the environment and keep out of reach from children.

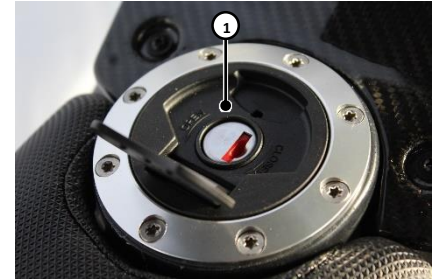

Note: Check if the fuel cap do not contain dirt or water, in order to let fuel cap breather work properly, avoiding injection malfunctions or engine stop.

GEARSHIFT PEDAL

The PR7 model is equipped with 6-speed transmission. On the left side of the engine is located the gearshift pedal (1). To shift gear properly:

- Actuate the clutch lever and close the throttle simultaneously to operate the gearshift pedal;
- Press down the gearshift pedal to engage a lower gear on the sequence.
Move upwards the gearshift pedal to engage a higher gear on the sequence;
- Slowly release the clutch lever to a smooth transition.

The gearshift lever will return to original position automatically when operated.

Neutral position is located between first and second gear. To engage neutral gear, shift to first gear, with clutch lever gripped, slowly up-shift gearshift pedal until neutral indicator light up in the instrument panel.

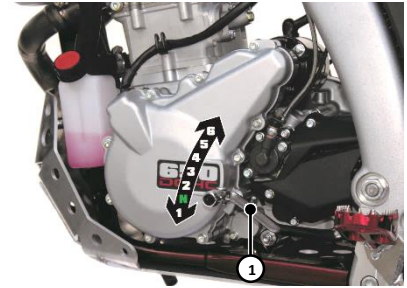

REAR BRAKE PEDAL

The rear brake pedal is placed on the engine right side. Pressing down the rear brake pedal (2) will actuate the rear brake. At the same time, the stop light in the taillight will switch on.

DANGER

A “spongy” front brake lever or rear brake pedal are indicators of a problem in the braking system. For safety reasons, do not ride the motorcycle until the braking system be checked by an AJP dealer.

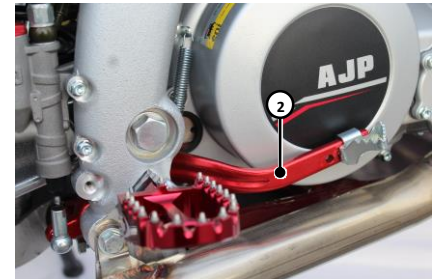

SIDE STAND

The motorcycle is equipped with a side stand on the left side. To place the motorcycle in side stand (1) push downwards using your foot until it stops. Then lean the motorcycle to the left. Ensure that the motorcycle is placed on solid ground and in a secure position.

To raise the side stand, hold the motorcycle in upright position, the side stand should fold automatically.

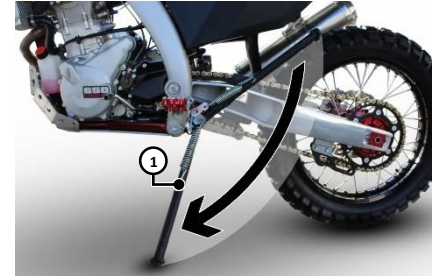

DANGER

Always inspect if side stand is raised up before each ride. The side stand can drag on the ground while driving and cause control loss.

WARNING

The side stand was designed only for the motorcycle weight. If there is additional load, the side stand or frame can be damaged and the motorcycle may fall over.

Park on solid and leveled ground to prevent the vehicle from falling over.

In case of parking on a sloped area, aim uphill the motorcycle front and engage first gear to reduce the chance of the side stand raising up.

Chapter C.

MAINTENANCE SCHEDULE

The maintenance schedule tables indicate the intervals between periodic services in kilometers or months. At the end of each interval, ensure to inspect, lubricate and service as instructed. If you ride the motorcycle under high stress conditions such as continuous full throttle operation or dusty climate, certain services should be performed more often to guarantee the reliability of motorcycle.

Your AJP dealer can provide you with further guidelines.

Steering components, suspension and wheel components are key items and require a special and careful service. For maximum safety, we suggest that you have these components inspected and serviced by your authorized AJP dealer.

DANGER Do not start engine in a closed area. Exhaust gases are poisonous and can cause loss of consciousness or even death. Always provide suitable ventilation while the engine is running.

DANGER It is owner's responsibility to assure that the motorcycle is serviced within the periodic maintenance schedule, in an authorized dealer workshop (preferably at the dealership where the vehicle was purchased). AJP does not take responsibility for any damage if maintenance was not performed as recommended schedule, which can lead to lose the warranty.

DANGER Improper or absence of recommended maintenance will increase the chance of accident or motorcycle damage.
Always follow inspection, maintenance recommendations and schedules in this user's manual.

WARNING Using poor quality replacement parts or materials can cause accelerated wear and shorten the motorcycle useful life. Use only genuine AJP spare parts.

The following table refers to the maintenance schedule that should be performed by AJP dealer to ensure correct operation.

Periodic maintenance tables (to be carried out at AJP Motos dealer)						
	1000 km	5000 km	10000 km	15000 km	20000 km	
ENGINE	Valve clearance	I/A	I/A	I/A	I/A	
	Intake/exhaust rocker arm			I	I	
	Timing chain				R	
	Timing chain guides				R	
	Timing gear				R	
	Timing chain tensioner		I	I	I	R
	Spark plug		I	R	I	R
	Spark plug cap		I	I	I	I
	Engine oil	R	R	R	R	R
	Oil strainer filter	C		C		C
	Main oil filter	R		R		R
	Clutch drive damper			I		I

A: Adjust

C: Clean

I: Inspect

L: Lubricate

R: Replace

Periodic maintenance tables (to be carried out at AJP Motos dealer)						
CHASSIS		After first 1000 km	Each 500 km or 1 month	Each 3000 km or 6 months	Each 6000 km or 12 months	Each 12000 km or 24 months
	Air filter (*)	I C	I C	I C	R	R
	Throttle cable			A L	A L	A L
	Clutch pump oil				I	R
	Cooling system tubes			I	I	I
	Suspension	I		I	I	I
	Front fork seals	C		I	L	R
	Front fork oil					R
	Braking system	I		I	I	I
	Braking fluid			I		R
	Electrical system	I		I	I	I
	Battery	I		I	I	I
	Fuel injection system			I	I	I
	Stop switches			I	I	I
	Steering components	I		I	L	L
	Drive chain	C L	I	C L	C L	R
	Side stand	I		I L	I L	I L
	Exhaust	I		I L	I L	I L
	Tightness review (nuts, bolts, ...)	I/A		I/A	I/A	I/A

A: Adjust

C: Clean

I: Inspect

L: Lubricate

R: Replace

(*) Clean or replace depending the air filter condition.

The following table refers to the maintenance schedule that should be performed by the owner to ensure the correction operation.

Periodic maintenance table (to be carried out by the owner)					
	After first 1000 km	Each 500 km or 1 month	Each 3000 km or 6 month	Each 6000 km or 12 month	Each 12000 km or 24 month
Engine oil level ^(*)	I	I ^(*)	I ^(*)	I ^(*)	I ^(*)
Cooling liquid level ^(*)	I	I ^(*)	I ^(*)	I ^(*)	R
Braking system fluid level			I	I	R
Brake pads			I	I	I
Drive chain	I	I C A L	I C A L	I C A L	R
Tires condition	I		I	I	I

A: Adjust

C: Clean

I: Inspect

L: Lubricate

R: Replace

^(*) Refill if necessary.

Note: Consult the Chapter D to see more information in detail.

Chapter D.

MAINTENANCE AND ADJUSTMENTS

In this chapter will be presented some procedures for the maintenance of the model covered in this manual. The technical information provided in this manual is a critical complement for the operator training and operators should become familiar with it. To ease understanding, diagrams and photographs are provided next to the text.

WARNING

When transporting your AJP ensure that the motorcycle is held upright with restrained straps. Be careful applying the straps to avoid damaging the front brake master cylinder or electric connections.

Use only special screws with an appropriate thread length, supplied by AJP, to fix the fuel tank. Using other screws or longer ones can cause cracks in the tank, which fuel can flow out through.

Let your motorcycle cool down before beginning any maintenance work in order to avoid get burned.

Remove methodically oil, grease, filters, fuel, cooling fluid, washing detergents, among others. To eliminate this hazardous waste without contaminating the environment, dispose the waste properly conditioned in a collection center for recycling.

Under no circumstance the used oil should be disposed in the environment, since it is highly polluting. Remember: 1 liter of used oil contaminates 1.000.000 liters of water.

LUBRIFICATION POINTS

Proper lubrication is important for smooth operating and long life of each working part of your motorcycle, as also for riding safe. It is a good practice to lubricate the motorcycle after a long rough ride or after getting in snow, water, mud or after washing it. Major lubrication points are indicated in this chapter.

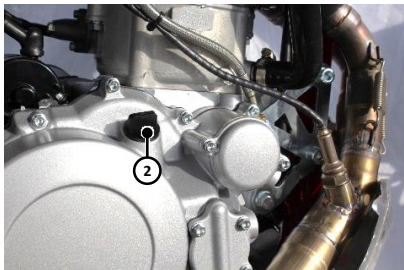
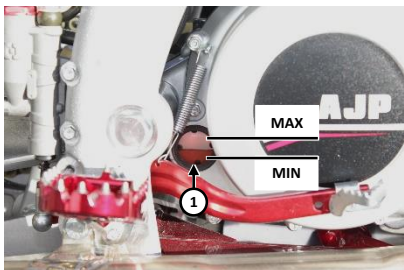

CHECKING ENGINE OIL LEVEL

On a leveled surface, place the motorcycle in an upright position. The engine oil level can be checked through the oil glass level (1).

With a warm engine, the oil level should be between the MAX and MIN marks.

WARNING

Engine oil level should be checked daily or before each ride. If necessary add oil to keep always between higher and lower mark.

If oil level drops quickly, do not ride your motorcycle. Consult an authorized AJP dealer immediately to full check the engine.

In order to refill the engine oil:

- Remove the oil filler cap (2);
- Add new engine oil through the filler hole;
- Start the engine and let it run for a short time (1-2 minutes);
- Check the engine oil level. If necessary repeat the process until the level is close to MAX mark.

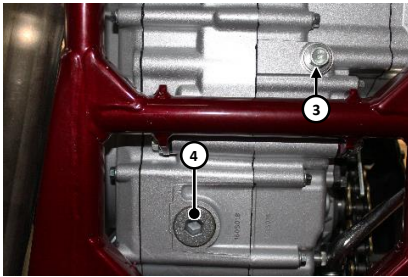
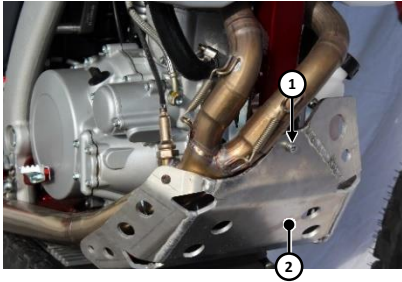

CHANGING ENGINE OIL

Engine oil must be changed with the engine in operating temperature. If the engine is not warm, start the engine and let it work for 5 minutes. To change the oil, follow this procedure:

- Unscrew the screw (1) and remove the engine skid plate (2);
- Place an appropriate container under the engine;
- Remove oil drain plugs (3) and (4) located at the lower part of crankcase;
- Drain the oil to the container avoiding spilling to the ground;
- Clean the magnetic plug (4) with solvent. Dry it with compressed air;
- Remove any remaining metallic particles of the magnet;
- Clean and check if the washers are damaged, replace if required;
- Remove oil filler cap and fill with 1.6 liters of recommended engine oil;
- Start the engine and let it on idle for two minutes;
- Check leaks and oil level, refill if necessary.

Drain plug (3) torque : 24 N.m (2.45 kgf.m)

Drain plug (4) torque : 30 N.m (3 kgf.m)

DANGER

In operating temperature, engine and engine oil are extremely warm. Be careful when changing engine oil, in order to avoid burns.

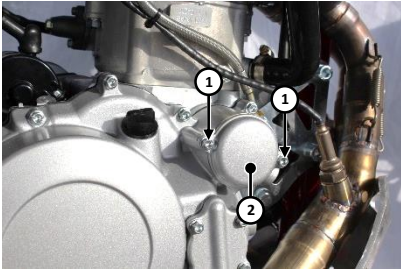

Note: We recommend that oil filters maintenance should be performed by an authorized AJP dealer.

REPLACING MAIN OIL FILTER

The main oil filter is located in right side of the crankcase. This component retains the dust and metallic particles, requiring periodically maintenance.

- Remove the engine oil (see CHANGING ENGINE OIL);
- Unscrew the screws (1) of the oil filter cover;
- Remove the oil filter cover (2);
- Remove the main oil filter (3) with a plier;
- Replace the main oil filter;
- Clean the oil filter cap with compressed air;
- Inspect the seal (O-ring) and replace if necessary;
- Install the main oil filter with hole end pointing to inside of the crankcase;
- Assembly the oil filter cover with the respective string and tight the screws;
- Remove oil filler cap and fill with 1,7 liters of recommended engine oil;
- Start the engine and let it on idle for about two minutes;
- Check leaks and the oil level, refill if necessary.

Main oil filter cover bold (1) torque: 9,3 N.m (0.95 Kgf.m)

WARNING

Avoid damaging the engine due insufficient lubrication. It is important to assure the correct position of the main oil filter.



CHECKING COOLANT LEVEL

The coolant expansion reservoir (1) ensure that the cooling liquid remains in the system when the liquid volume expands due the increment of the pressure/temperature.

Inspect the coolant level often. Always control the coolant level with the engine cold. To inspect the coolant quantity:

- Level the motorcycle horizontally and vertically;
- Verify if the coolant liquid level is located approximately at 50% of the expansion reservoir (1);

Never check the coolant liquid level with a warm engine. The system will be pressurized and can expel liquid, causing injuries and burns.

DANGER

Never start the engine with low level or without coolant liquid. The engine may overheat and get damaged.

Do not cover the radiators. Maintain protection louvers and radiators clean. Otherwise, the heat exchange will be reduced and result in engine overheat.

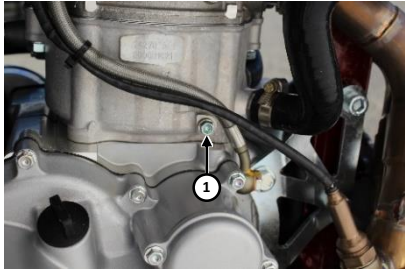

REPLACING COOLANT LIQUID

In order to replace the cooling liquid, follow the next procedure:

- Remove the screw (1);
- Collect the liquid to an appropriate recipient ;
- Place back the screw (1);
- Fill the radiator with approximately 1.3 liters of recommended coolant liquid;
- Fill the expansion reservoir with 30% of its capacity.

Recommended coolant liquid : ENI Permanent Spezial



RADIATOR FAN

The radiator fans (2) are located on the back side of both radiators. The fans are activated automatically when the coolant liquid temperature reaches approximately 95°C, being deactivated when the temperature drops below the 85°C.

If you notice that the expansion tank is full, this may indicate that the engine has overheated. You should go to your dealer as soon as possible in order to find out the cause of the problem in the cooling circuit in order to avoid damage to the engine.

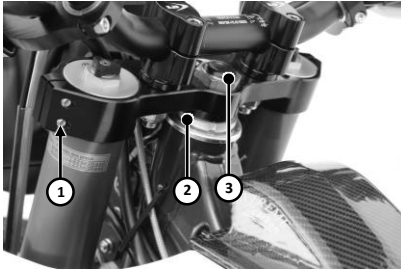

Note: The steering head bearings should not adjusted to be tight or loosen.

CHECKING AND ADJUSTING THE STEERING HEAD BEARINGS

Verify steering head bearings clearance regularly. To check, place the motorcycle on a stand so that the front wheel is off the ground.

- Try to move the fork forward and backward;
- Loosen top nut (3) and the four screw (1) of the top triple clamp;
- Turn steering column nut (2) clockwise, with the proper tool, until there is no more play. Do not tighten the steering stem all the way, otherwise the bearings will be damaged;
- With a plastic hammer, lightly tap on triple clamp to release tension;
- Tight the top nut (3) and top triple clamp screws (1) with the proper torque.

Steering head bearings should be greased at least once a year.

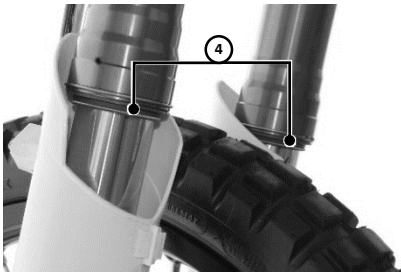

CLEANING FRONT FORK DUST SEALS

The dust protection seal (4) has two functionalities: prevent the dirt going inside the suspension system and remove the dirt of the front fork in compression solicitations.

However, after some time, dirt may get and accumulate behind this seals. If dirt is not removed, oil retention seals can be damaged and start leaking.

- Use a screwdriver gently to remove the dust seals (4) without damaging the fork tube;
- Move the seals downwards along the tube;
- Clean the dust seals and front fork tubes thoroughly;
- Lubricate this components with silicone spray or engine oil;
- Push the front fork dust seals back to the original position manually.



ADJUSTING FRONT FORK SUSPENSION

To adjust rebound of the suspension system:

- Turn the screw (1) clockwise in order to decrease the rebound speed.
- Turn the screw (1) counter-clockwise increase the rebound speed.

Standard setting: 12 clicks from the fully closed position

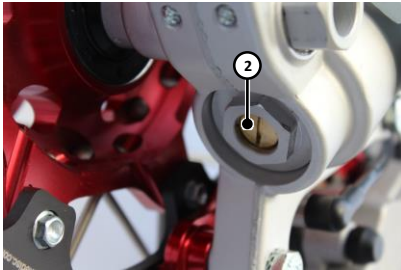

To adjust compression of suspension system:

- Turn the screw (2) clockwise to a harder response.
- Turn the screw (2) counter-clockwise to a softer response.

Standard setting: 12 clicks from the fully closed position

Note: Turn clockwise (+) the screws (1) and (2) to place in fully closed position, without additional effort to prevent damaging the internal parts.

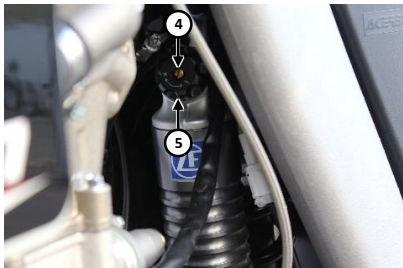
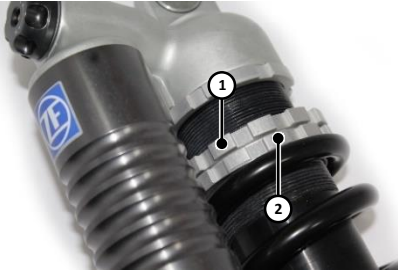

ADJUSTING REAR SUSPENSION

The AJP PR7 model is equipped with a fully adjustable shock absorber.

To adjust the preload:

- Loose the upper nut (1);
- Turn the adjusting nut (2) clockwise for more preload.
Turn the adjusting nut (2) counter-clockwise for less preload.

In order to adjust the rebound :

- Rotate screw (3) clockwise to decrease the rebound speed.
- Rotate screw (3) counter-clockwise to increase rebound speed.

To adjust low or fast compression damping, rotate the screw (4) and adjuster (5) respectively.

- To decrease the compression speed, turn clockwise.
- To increase the compression speed, turn counter-clockwise.

DANGER

Improper servicing of the rear shocks absorber is dangerous. The rear shock contains high-pressure gas and can explode when handled improperly.

Standard settings

Rebound: Turn counter-clockwise (S) until make 14 clicks from the closed position.

Low compression: Turn 12 clicks counter-clockwise (-) from the closed position.

Fast compression: Turn 10 clicks counter-clockwise (-) from the closed position.

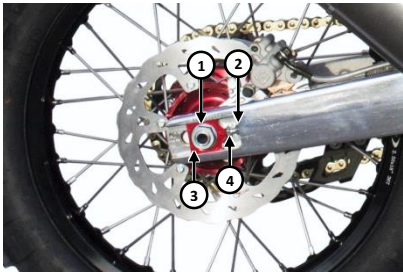
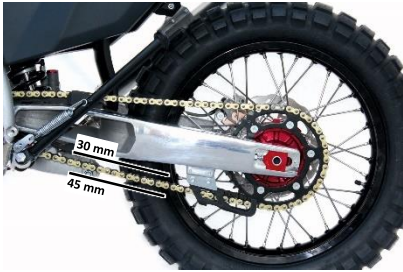

ADJUSTING DRIVE CHAIN

The drive chain clearance must be between the 30 to 45mm interval, at the half way between the drive sprocket and rear sprocket.

To adjust the tightness, place the motorcycle on the side stand.

- Loosen the axle nut (1);
- Loosen the fixing nuts (2) on the both sides;
- Adjust the adjuster screws (4) until the clearance of drive chain is within specifications. Simultaneous, ensure that the rear sprocket is aligned with drive sprocket;
- Check if the chain tensioners (3) are aligned with the reference marks on swing arm. If they are not visible, measure the distance between tensioners and swing arm end;
- Tight securely the axle nut and afterwards the fixing nuts;
- Verify the chain clearance after the procedure;
- Lubricate and adjust if necessary.

Excessive tension of the drive chain will produce additional load on the components. Aside from resulting on premature wear, the drive chain may break.

DANGER

Excessive drive chain clearance can result in chain jumping off from the chain sprockets. In this case, the chain can also block the rear wheel or damage the engine.

In both cases, the rider can lose control of the motorcycle.

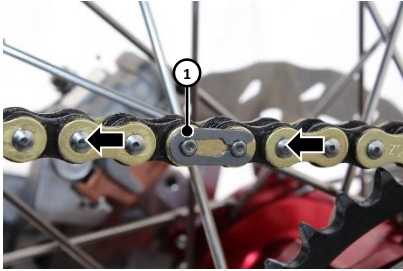

DRIVE CHAIN MAINTENANCE

A good maintenance is extremely important for long chain life. O-ring chains are simple to clean. Clean with water and never use brushes or cleaning liquids. After letting dry completely, use a chain spray to lubricate it.

Also check sprockets and chain guides wear, replace if necessary.

DANGER

Never let grease or lubricant reach rear tire or brake disc. Otherwise, road adherence and the braking effects will be strongly reduced, which can cause control loss.

WARNING

During the assembly of the chain master link clip (1), assure that the closed side of the master link is pointing on running direction.

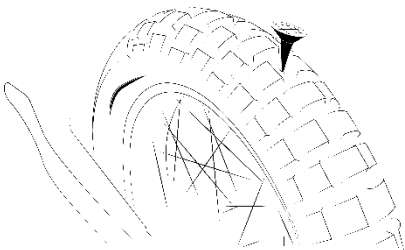

TIRES CONDITION

Tire model, condition and air pressure affect the motorcycle behavior. Therefore, tires must be checked before riding.

- Tire size can be found in the technical specifications and registration documents.
- Before riding, inspect the tires for punctures and nails or other sharp objects that might have stuck.
- Be aware of specific regulations in your country for minimum tire tread requirements.

DANGER

Replace damaged tires immediately. Worn tires could have negative effect on the motorcycle performance, especially on wet surfaces.



Note: The correct tire pressure depends on the road/terrain surface type.

TIRES PRESSURE

Tires pressure should be checked regularly with “cold” tire. Proper pressure ensures optimum driving comfort and extends the tire life.

The pressure values (see Chapter E) are indicated for road use. For an off-road use, we recommend a lower pressure to assure traction. In these conditions, it is recommended 1.5 bar (21 psi) in both tires.

WARNING

Tires air pressure with too low/high values cause abnormal wear and overheating. Correct the pressure every ride.



CHECKING SPOKES TENSION

Correct spokes tension is extremely important for a riding safety. Loose spokes induce unbalanced areas on wheel, letting other spokes to become loose.

Check spokes tension, especially on a new motorcycle, in regular intervals.

To inspect use a screwdriver to slightly sweep the spokes. Spokes with same dimensions should have the same sound. If necessary, have the spokes retightened and wheel correction by an AJP dealer.

DANGER

Spokes can break apart in extreme requests or riding with incorrect tension. This may lead to an unstable behavior of the motorcycle.

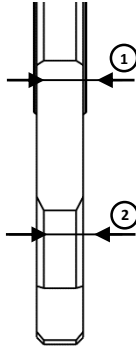

BRAKE DISC

Due to wear, the thickness of brake discs in the contact area of the brake pads starts to decrease. At their thinnest point (2), the brake discs shall not be less than 0.50 mm thinner than nominal thickness. Measure the nominal thickness in the zone (1) outside of contact area and check for wear in several points.

DANGER

For your own safety replace the brake discs as soon as they reach wear limit (3.8 mm for the front disc and 4.5 mm for the rear disc).

Any repair on brake system should be performed by an authorized AJP dealer.



BRAKE DISC

The sintered brake pads used on the PR7 front and rear brake systems provide an optimal combination of brake power, performance and lifecycle.

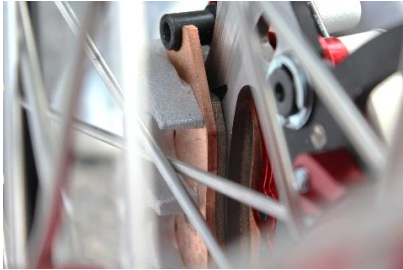

CHECKING FRONT BRAKE PADS

The front brake pads can be inspected through the spokes on the opposite side of the brake system, as showed in the picture. The linings must have at least 1 mm thickness.

DANGER

At their most worn point, brake pad linings should not be thinner than 1 mm, otherwise can lead to braking failure.



CHECKING REAR BRAKE PADS

The rear brake pads can be inspected from the rear side of the motorcycle. The linings cannot have less than 1mm thickness.

DANGER

If brake pads are replaced too late, steel components of brake pad will rub against brake disc. Thereby, braking effect will be reduced and destroying the brake disc.

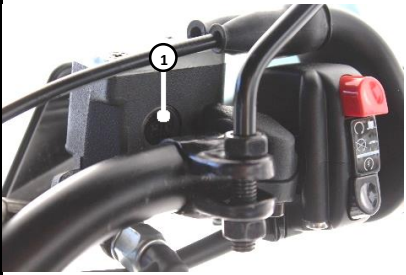

FRONT BRAKE MASTER CYLINDER

The front brake master cylinder have been designed in such a way that even if the brake pads are worn, it is not necessary refill the reservoir. If brake fluid level drops below the minimum level either there is a leak or the brake pads are completely worn.

In this case, consult an authorized AJP dealer immediately.

DANGER

Change brake fluid at least once each two years. If you wash your motorcycle often or wet environments, brake fluid should be changed even more often (once a year), since the brake fluid tends to absorb water.

Vapor pockets can form on “old” brake fluids even at low temperatures, causing brake system to fail.

CHECKING FRONT BRAKE FLUID LEVEL

Brake fluid reservoir is linked with the front brake master cylinder in the handlebar and equipped with a level inspection glass (1). With the reservoir horizontally leveled, the brake fluid level should not drop below the middle of the level glass.

DANGER

Brake fluid can cause skin irritation. Avoid contact with skin and eyes. If you get brake fluid in your eyes, clear with plenty of water and look for medical assistance.

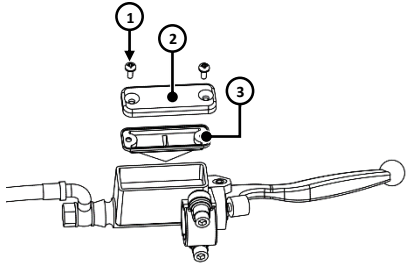

REFILLING FRONT BRAKE FLUID

- Remove the screws (1);
- Remove the reservoir cover (2) and the diaphragm (3);
- Place front brake reservoir in a horizontal position and fill up the reservoir until the MIN mark with clean brake fluid DOT 4;
- Replace diaphragm, cover and screws if damaged;
- Clean the spilled or overflowed brake fluid with water.

WARNING

Do not let brake fluid get in contact with paint. Brake fluid is highly corrosive and may damage painted parts of the vehicle.

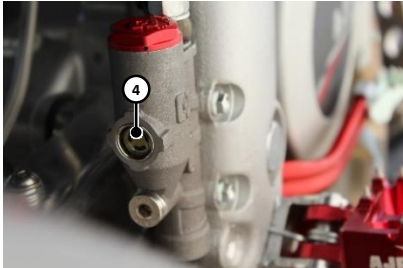

CHECKING REAR BRAKE FLUID LEVEL

The rear brake reservoir is integrated in brake master cylinder and is located on the right side of the motorcycle, near of the swing arm.

Verify the brake fluid level in the level glass (4).

WARNING

The oil level must be above the MIN mark when the motorcycle is in the upright position.

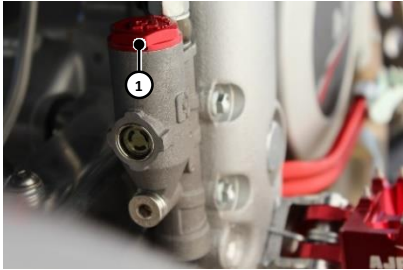

REFILLING REAR BRAKE FLUID

- Remove the master cylinder cover (1);
- Place rear brake master in a horizontal position and fill up the reservoir until the MIN mark with clean brake fluid DOT 4;
- Replace diaphragm and reservoir cover if damaged;
- Clean the spilled or overflowed brake fluid with water.

WARNING

Do not let brake fluid get in contact with paint. Brake fluid is highly corrosive and may damage painted parts of the vehicle.

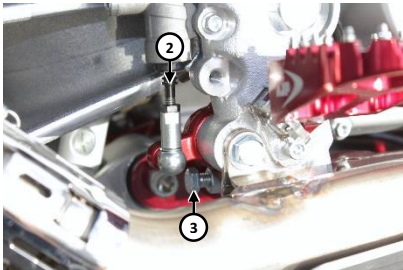

CHANGING REAR BRAKE PEDAL POSITION

The rear brake pedal position can be modified rotating the bolt (3).

Adjust the piston rod (2) to control the brake pedal free play. The rear brake pedal must have 1 to 2 mm of free play.

DANGER

If there is no brake pedal free play, the pressure can build up in brake system while driving and block the rear wheel. Brake system can overheat and even completely fail in extreme cases.

Do not press continuously the rear brake pedal while riding.



REMOVING THE BATTERY

The battery (2) has a closed system and therefore requires no maintenance (MF). Keep the battery poles clean and put slightly acid free grease if necessary.

To remove the battery:

- Turn the seat lock (1) with ignition key and remove the motorcycle seat. The battery is located above rear wheel;
- Disconnect the negative pole (-) and then the positive pole (+) of the battery;
- Unhitch the rubber band (3);

On assembly, first connect the positive pole and then the negative pole.

After installing the battery, or replacing any fuse, do not immediately start the engine. You must always perform the reset procedure on the injection system to prevent engine malfunction.

In case of motorcycle storage for a long period, remove the battery and recharge it every month in normal charge mode. Keep storage in a dry place and with temperatures between 0-35°C. Do not let the battery exposed to direct sun radiation.

DANGER Battery is a closed model (MF) but can nevertheless emit explosive gases. Avoid sparks and fire near the battery.

WARNING Never reverse polarity or disconnect the battery while the engine is running, otherwise the battery, voltage regulator-rectifier or other electric components will be damaged.

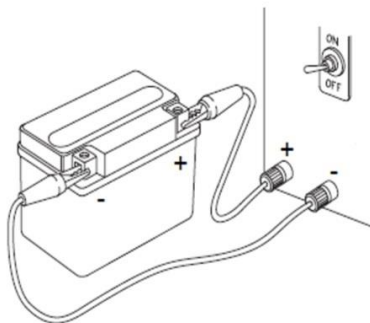

Recharge method	Recharge current	Recharge time
Normal	1.4 A	5 ~ 10 Hours
Fast	14 A	1 Hour

Note: The battery must be recharged with a proper automatic battery charger. The charger should turn off when the battery voltage is 14.4 V. The manufacturer recommends the product Shorai BMS01 Charger/Storage System.

RECHARGING THE BATTERY

Motorcycles stored for long periods or equipped with additional electronic accessories will cause battery discharge.

The battery should be charged when identified issues as instrument panel malfunction, electronic starter motor malfunction or engine power loss due the injection system errors.

In case of home battery recharge:

- Remove the battery (see REMOVING THE BATTERY);
- Place the battery in a clean, dry and ventilated area. Keep out of ignition sources or inflammable substances;
- Inspect the battery charger. Ensure that it is in good conditions and set with right values;
- Connect first the terminal clamps in the battery. Then plug the charger to a 110 VAC - 220 VAC electric network;
- Check the voltage. The battery voltage should be in 13.9 V to 14.4 V range.

WARNING

Do not let the battery voltage drop below 13.1 V. Improper voltage can lead to problematic starts, fuel injection system errors or performance loss.

Use a recommended charger. Incorrect charger configurations can damage or destroy the battery.

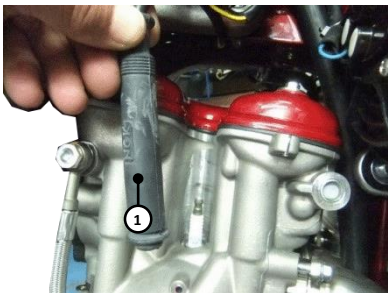

CHECKING SPARK PLUG

Sparks plugs are important components to a maximum performance and smooth ride. Therefore, spark plugs must have a correct clearance (see Chapter E) and be checked periodically.

Removal

Disconnect the spark plug cap (1) and clean the spark plug base's periphery with compressed air. To remove the spark plug, you must use a suitable 16 mm spark plug wrench.

Spark plug Inspection

Inspect visually the spark plug, if necessary replace it

Adjusting the gap between the electrodes

Measure the spark plug electrode gap with a feeler gauge. Adjust the gap by carefully bending the electrode.

Reusing a spark plug

Clean the spark plug electrodes with a wire brush or a special spark plug cleaning agent.

Replacing a spark plug

The new spark plug should be NGK CR8EB. Check and adjust the clearance with a feeler gauge.

Assembling

Point the spark plug and manually tighten it as tightly as possible. If you are installing a new spark plug, do another $\frac{1}{2}$ turn after the washer has seated in the base. If you are installing a reused spark plug turn another $\frac{1}{4}$ turn after the washer has seated in the base.

If using a torque wrench, apply the specified tightening value: **13N.m (1.3Kgf.m)**

WARNING

Incorrect spark plug clearance or maintenance procedures can reduce the performance or cause engine malfunction.

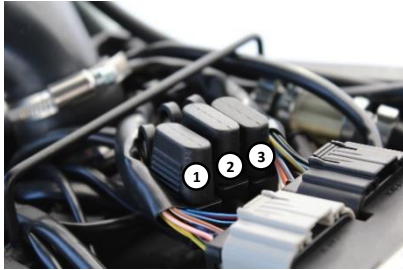

Note: The harness wires after the fuses are identified with the respective color of the fuses.

FUSES

The fuses are disposed underneath the seat, close to the ECU. Turn the seat lock with ignition key and remove the motorcycle seat to get access to the fuses. There are:

1. One 20 A fuse (yellow) for the electric system;
2. One 15 A fuse (blue) for the injection system;
3. One 10 A fuse (red) for the tablet;

The protection covers must be kept perfectly fitted at their holder to avoid losing a fuse. There should be a spare fuse kit between the rubber band and the battery.

Replace a blown fuse only with an equivalent one. If a new fuse recently installed gets blown, we recommend that your motorcycle be inspected by an AJP dealer.

WARNING

Under none circumstances allow the installation of a stronger fuse or repair a damaged one. An inexpert treatment could damage the entire electrical installation.

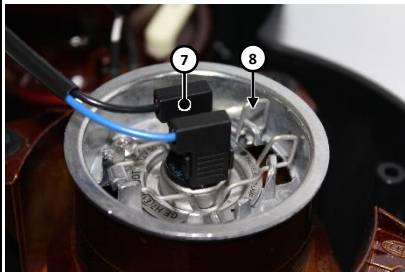

REPLACING HEADLIGHT LAMP

To replace the headlights lamps ensure the key in the ignition switch is in the OFF position or LOCK position.

- Remove the bolt (2) e (4);
- Loosen the screw (5) located behind the fairings;
- Remove the windshield (1);
- Disconnect the connectors behind headlight group;
- Unscrew the two fixation screws (3) and remove the headlight group;
- Place the headlight group with the lights pointing down and loose the six self-tapping screws (6);
- Remove the headlight cover and then release electrical terminals (7);
- Press the retention spring ends (8) and remove it.

The headlight lamp should be released. Replace with the new one.

In order to assembly, reverse the previous procedure.

WARNING

Do not replace H7 headlight lamp for another model or with different power that the one specified to AJP PR7 model.

Do not touch lamp glass, otherwise some substances can cause overheating and lamp lifetime reduction. In that case, clean with alcohol and let it dry.



REPLACING TAILLIGHT

The taillight (1) is composed by a set of LEDs and does not allow replacing them. In case of presence or stop light failure, the taillight must be replaced.



REPLACING TURN INDICATOR LIGHTS

The LED turn signals (2) on the AJP PR7 are not repairable. Replacement of turn signals should only be performed by an authorized AJP dealer.



TABLET CASE ASSEMBLY

The Tablet is an important motorcycle's component, so it must be handled correctly and carefully. For a correct tablet box's assembly to the motorcycle:

1. Insert the pivot bush (1) in the tablet case support and align with the metal support;
2. Press the pivot bush (1) to fit between the metal support plates;
3. Align the pivot bush hole (1) with the upper hole in the metal support;
4. Insert the hex screw (2) in the right side of the motorcycle;
5. Place the hex nut (3) on the end of hex screw (2). Tighten the hex nut with two 10 mm wrenches. Check the movement of the tablet case, adjust the torque if necessary;
6. Insert the hex screw (4) in the lower hole of the metal support;

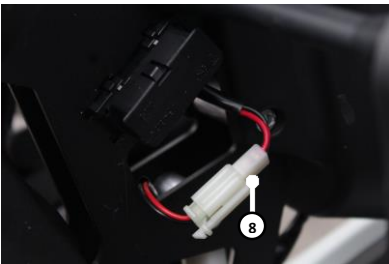
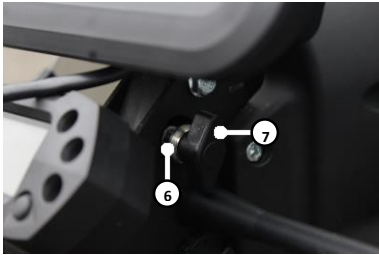
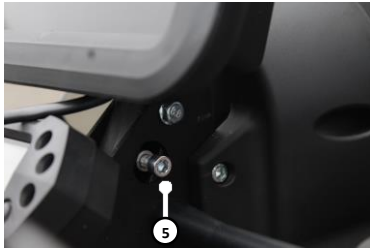

TABLET CASE ASSEMBLY

7. Match the threaded bush (5) and screw set with the hex screw (4). Tighten the hex screw (4) using a 8 mm wrench while holding the screw with a 5mm Allen screwdriver. Remove the screw;
8. Insert the flat bush (6) with the bigger side facing the bush and the adjustment knob (7). Tighten the adjustment knob;
9. Pass the tablet power source connector between the metal support plates;
10. Plug the tablet power source connector to the respective harness connector (8). Place the connector between the metal support plates.

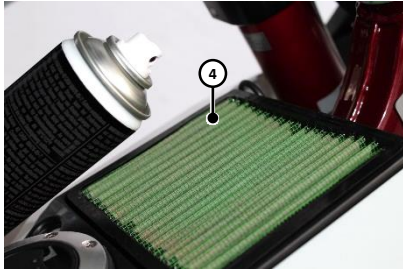
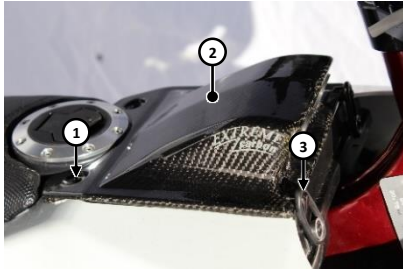

CLEANING AIR FILTER

Dirty air filters (4) causes airflow restriction, reducing the engine performance and increasing fuel consumption. Therefore, clean regularly the air filter. To access the air filter:

- Release the two rubber bands (3);
- Unscrew the screws (1);
- Remove the air filter cover (2);
- Pull the rubber ends of the air filter to remove it from air box;
- Clean thoroughly the air filter with a special cleaning fluid and let it dry completely;
- Apply high-grade filter oil on both sides of the dry filter and clean the air box.

WARNING

Do not clean the air filter with fuel or solvents that can damage the cotton.

Maintain the air filter clean and lubricated (do not over apply, only oil wet) to assure effective protection to the engine.

Never start your motorcycle without air filter. Otherwise dust or dirt may penetrate in the engine, damaging or severe wearing the engine components.



CHECKING EXHAUST SYSTEM

The exhaust system (1) requires regular maintenance, especially when often exposed to severe condition of motorcycle riding. Make sure all exhaust components are in perfect working order.

Regularly check the fixing of the muffler (2). Make sure it doesn't touch the swing arm. In case of fall, contact your AJP Dealer to adjust the muffler position on the fixing clamp. This will ensure the muffler is aligned and it doesn't touch the swing arm.

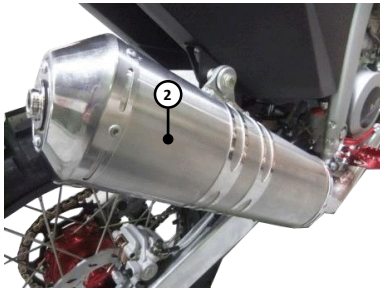

DANGER

Exhaust system can reach high temperature in operation. Be careful handling the motorcycle even after parking in order to avoid burns.

Wear suitable clothes and boots to protect you from the high temperatures of the exhaust system.

Park the motorcycle in clear area, keep out of reach inflammable substances and children.

Chapter E.

TECHNICAL SPECIFICATIONS

Engine

Type	Single cylinder, 4 stroke, DOHC
Cooling	Liquid cooled with dual electric fan
Displacement	600 cc
Bore	100 mm
Stroke	76.4 mm
Compression ratio	12.4:1
Start	Electric
Fuel	Unleaded fuel 95
Fuel consumption	3.7 L/100 km
CO ₂ emission	83 g/km

TIMING SYSTEM

Type	4 valves, dual overhead camshaft (DOHC), commanded by silent chain
Valve clearance (cold engine)	
Intake	0.10 - 0.15 mm
Exhaust	0.15 - 0.20 mm

LUBRICATION

Type	Wet sump with lobe pump, cartridge oil filter and two oil strainer filters
------	--

IGNITION

Type	ATHENA, electronic with automatic advance adjustment (digital control)
Spark plug type	NGK CR8EB
Spark plug electrode gap	0.6 - 0.7 mm

FUEL SYSTEM

Type	Electronic fuel injection, AJP Ø45 mm throttle body
------	---

CLUTCH

Type	Oil bath multiple disc clutch, hydraulic control
------	--

TRANSMISSION

Type	Constant mesh gear type
Total of gears	6
Primary ratio	Z75/Z32
1 st gear ratio	2.615 (Z34/Z13)
2 nd gear ratio	1.812 (Z29/Z16)
3 rd gear ratio	1.350 (Z27/Z20)
4 th gear ratio	1.091 (Z24/Z22)
5 th gear ratio	0.957 (Z22/Z23)
6 th gear ratio	0.880 (Z22/Z25)
Final ratio	Z45/Z15

CHASSIS

Type	Double cast aluminium beam + steel sub-frame + rear steel square tubes
------	--

FRONT SUSPENSION

Type	Upside down telescopic fork ZF SACHS 48 mm
Diameter	Ø 48 mm
Stroke	300 mm - Fully adjustable

REAR SUSPENSION

Type	AJP progressive linkage system, ZF SACHS Piggyback shock
Stroke	280 mm - Fully adjustable

FRONT BRAKE

Type	Double piston caliper
Brake disc	Floating disc
Brake disc diameter	Ø 300 mm

REAR BRAKE

Type	Single piston floating Caliper
Brake disc diameter	Ø 240 mm

FRONT WHEEL

Rim size	21"x1.60	
Tires	Continental - TKC Twinduro	Michelin - Desert
Tires size	90/90 - 21"	90/90 - 21"
Pressure (road with maximum load)	2.3 bar	

REAR WHEEL

Rim size	18"x2.50	
Tires	Continental - TKC Twinduro	Michelin - Desert
Tires size	140/80 - 18"	140/80 - 18"
Pressure (road with maximum load)	2.3 bar	

CAPACITY

Fuel tank capacity	17 L
Fuel reserve	3 L
Coolant system capacity	1.3 L
Engine oil replacement	1.6 L
Main engine oil filter replacement	1.8 L

LUBRICANT TABLE, SUPPLIERS

Engine and gearbox lubricant	ENI i-Ride MOTO 10W-50
Coolant liquid	ENI PERMANENT SPEZIAL
Air filter lubricant	Green Filter oil
Brake fluid	ENI DOT 4 SAE J 1704
Clutch fluid	Multi-tech CT 10 W
Lubricant grease	ENI AGIP GR MU EP 2
Drive chain lubricant	AGIP CHAIN GREASE SPRAY
Suspension oil	
Front	ENI FORK OIL SAE 5W
Rear	ENI FORK OIL SAE 5W
Electric contact protection	ENI i-Care CONTACT CLEANER

OVERALL DIMENSIONS

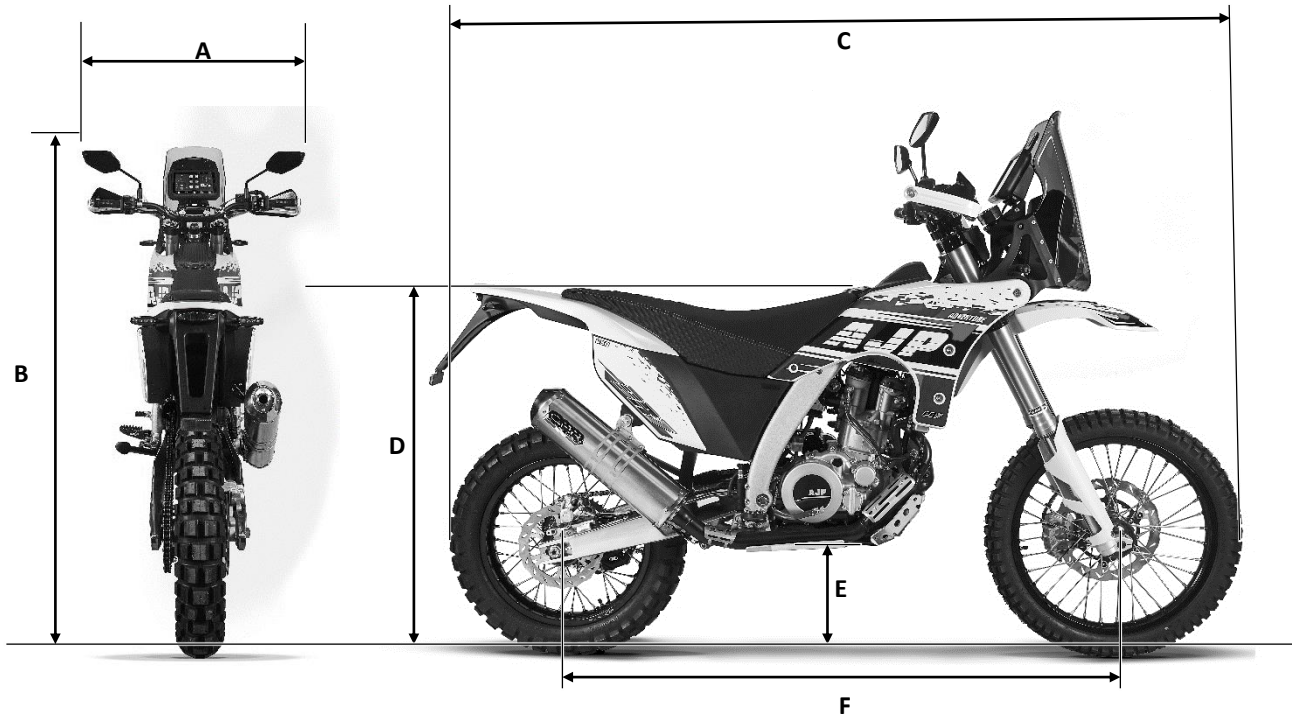

OVERALL DIMENSIONS

POSITION	DIMENSIONS (mm)
A	810
B	530
C	2270
D	920
E	310
F	1540



www.ajpmotos.com

Rua de Santana, 91 info@ajpmotos.com
4620-510 Pias, Lousada - PORTUGAL Tel: +351 255 815 122